

PLANTA DE PRODUCCIÓN DE ETILBENCENO

GRADO DE INGENIERÍA QUÍMICA



Irene Benítez

Antonio Funes

Eduardo Larrousse

María Lozano

Arnau Mestre

Joel Méndez

Judith Royo

Curso 2022/2023
Tutor: Josep A. Torá
Grupo: 4

PLANTA DE PRODUCCIÓN DE ETILBENCENO

CAPÍTULO X: DIAGRAMAS Y PLANOS



Irene Benítez

Antonio Funes

Eduardo Larrousse

María Lozano

Arnau Maestre

Joel Méndez

Judith Royo

Curso 2022/2023
Tutor: Josep A. Torà

Nitrógeno (N)	
Reactivo (R)	
Producto (P)	
Aire (AV)	
Agua (AR)	
Gases de escape (EG)	
Combustibles (FG)	
Etilengicol (AG)	
Vapor (AT)	
Etilbenzeno (EB)	
Línea eléctrica	
Línea neumática	

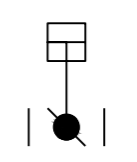
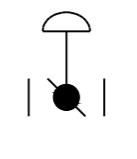
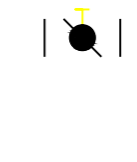
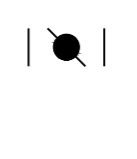
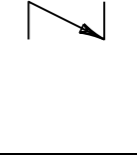
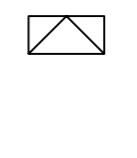
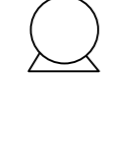
	Válvula on/off
	Válvula de control
	Válvula manual
	Válvula de mariposa
	Válvula antiretorno
	Disco de ruptura
	Bomba

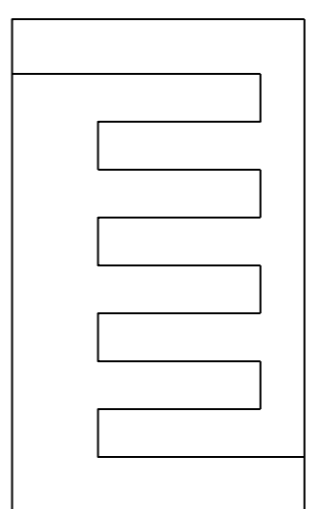
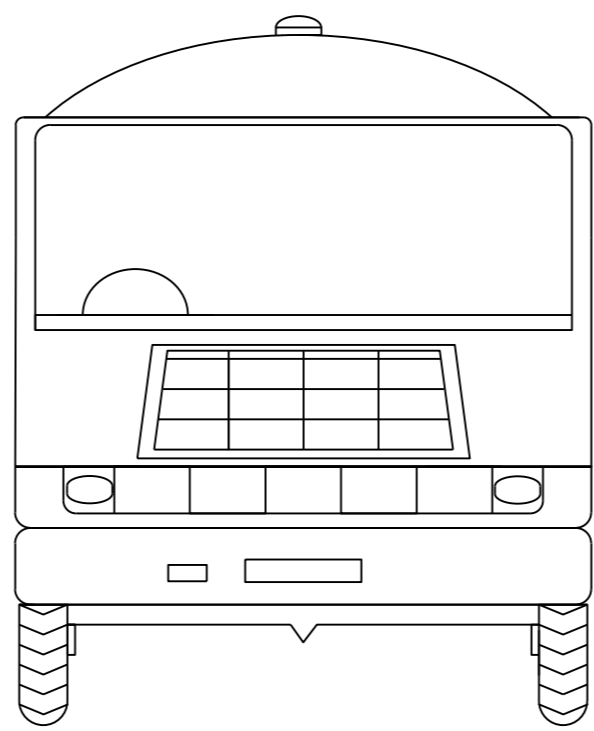
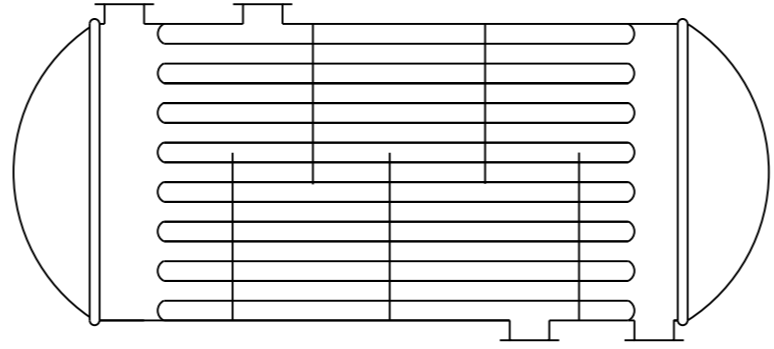
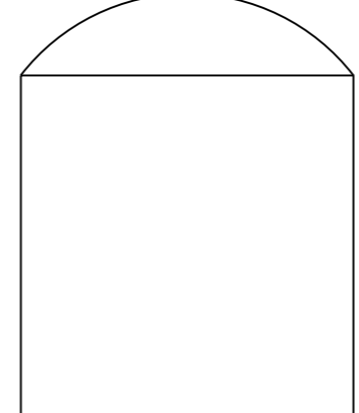
Condensador	
Camión	
Intercambiadores	
Tanque de mezcla	

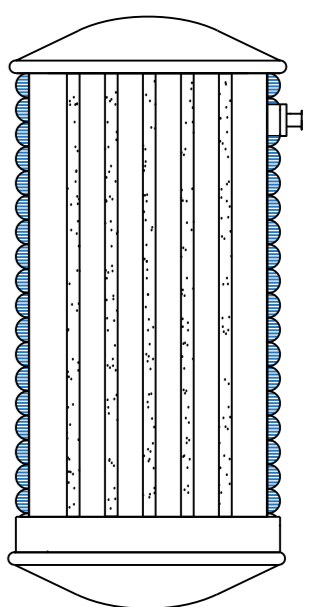
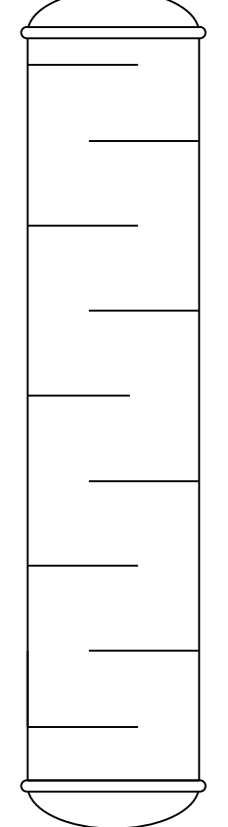
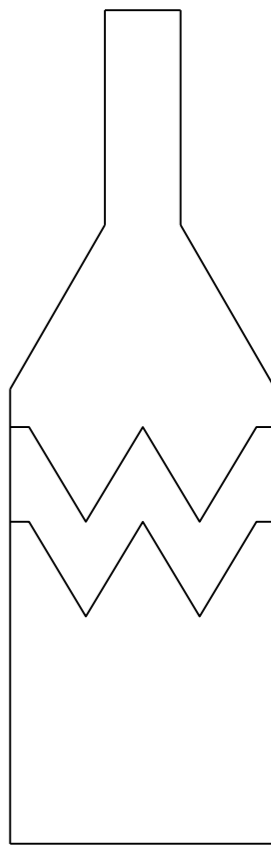
Reactor	
Columna de destilación	
Horno	

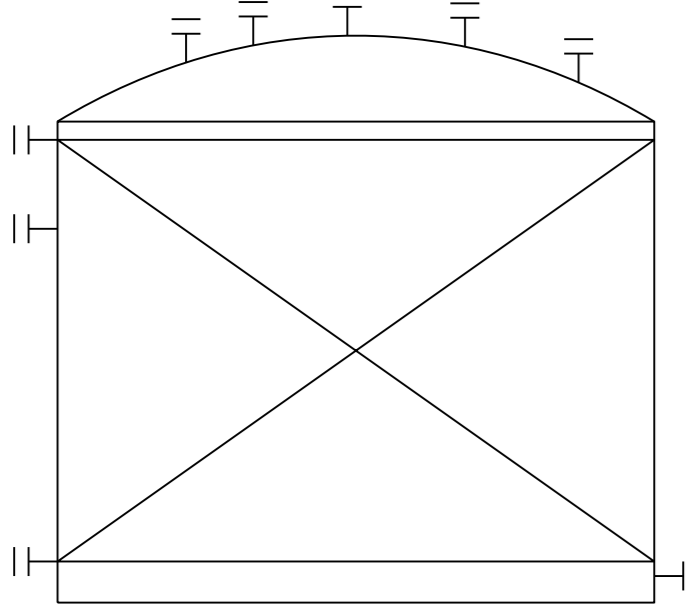
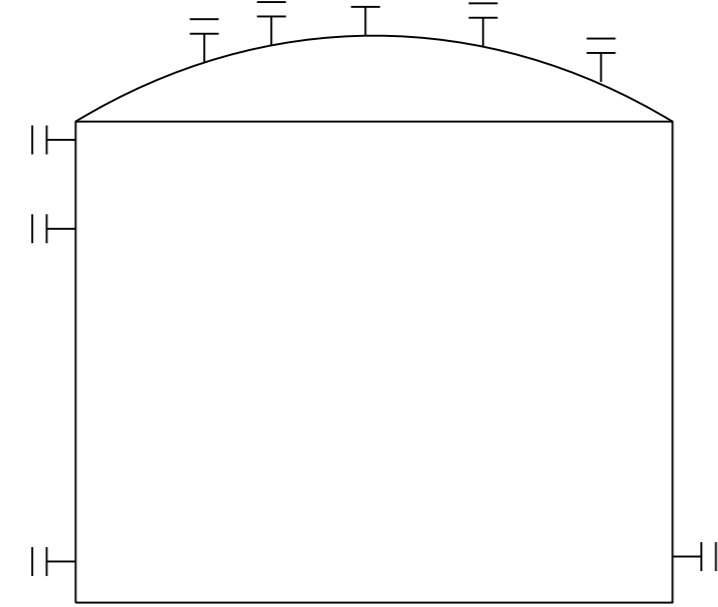
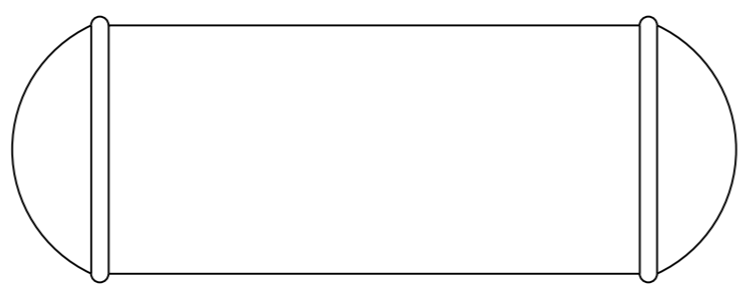
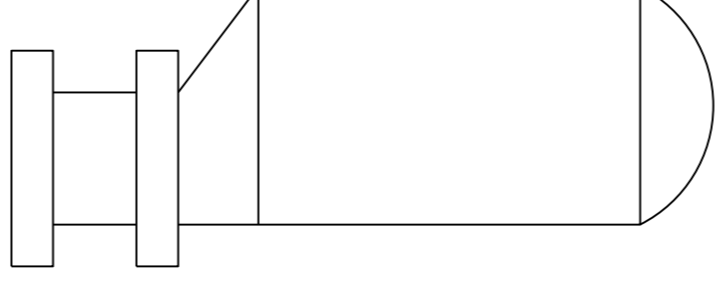
Tanque de almacenamiento de producto	Tanque de almacenamiento de reactivos	Tanque de condensados	Reboiler
			

Plano n°: 01	Leyenda de equipos y líneas de circulación.
Dibujado: 10/04/2023 Revisión: 09/06/2023 Aprobado: 11/06/2023	Fecha: 13/06/2023 Localización: Planta de gases nobles, Tarragona



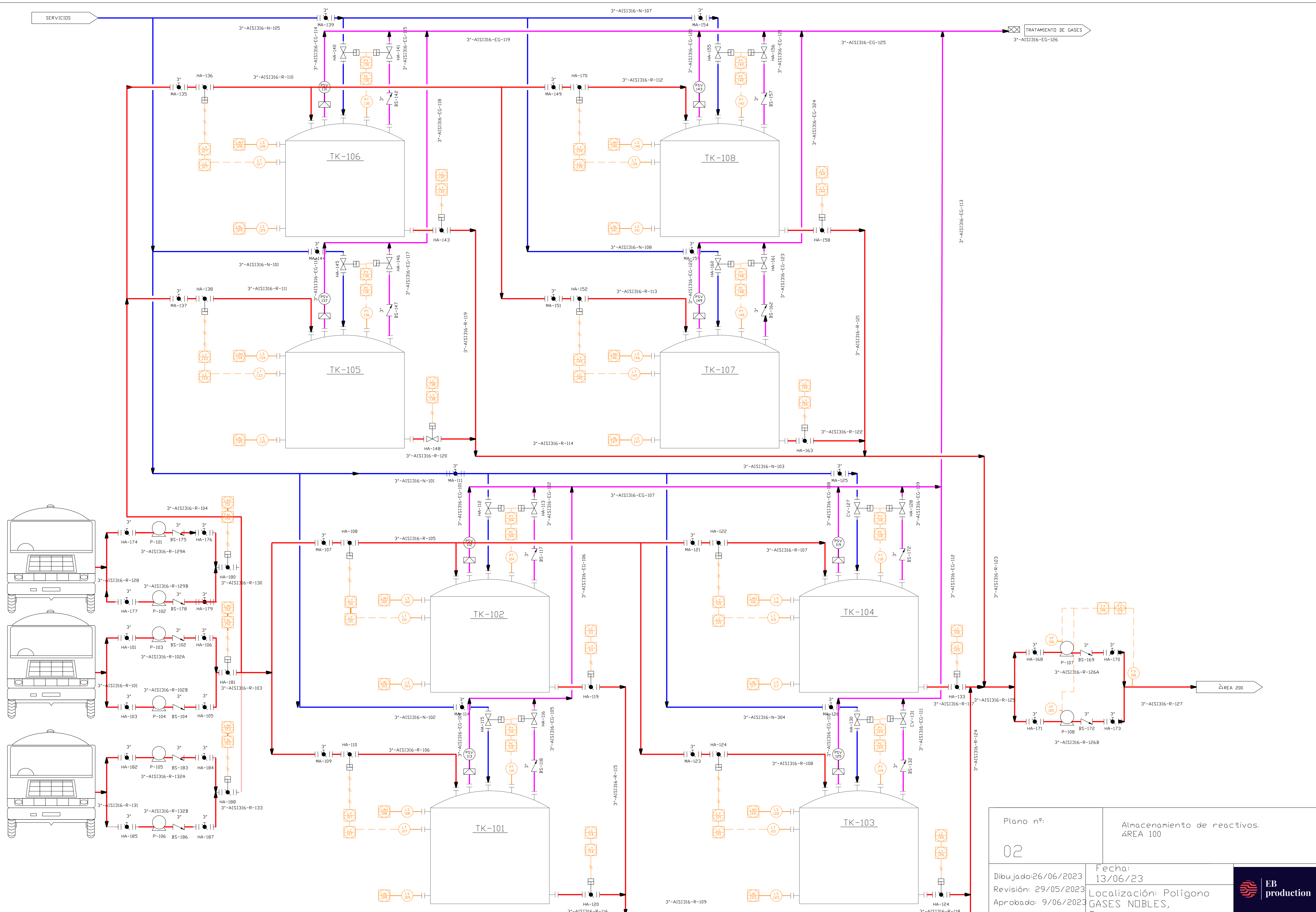

Plano nº:	Almacenamiento de reactivos. ÁREA 100
02	
Dibujado: 26/06/2023	Fecha: 13/06/23
Revisión: 29/05/2023	Localización: Polígono GASES NOBLES, Tarragona
Aprobado: 9/06/2023	



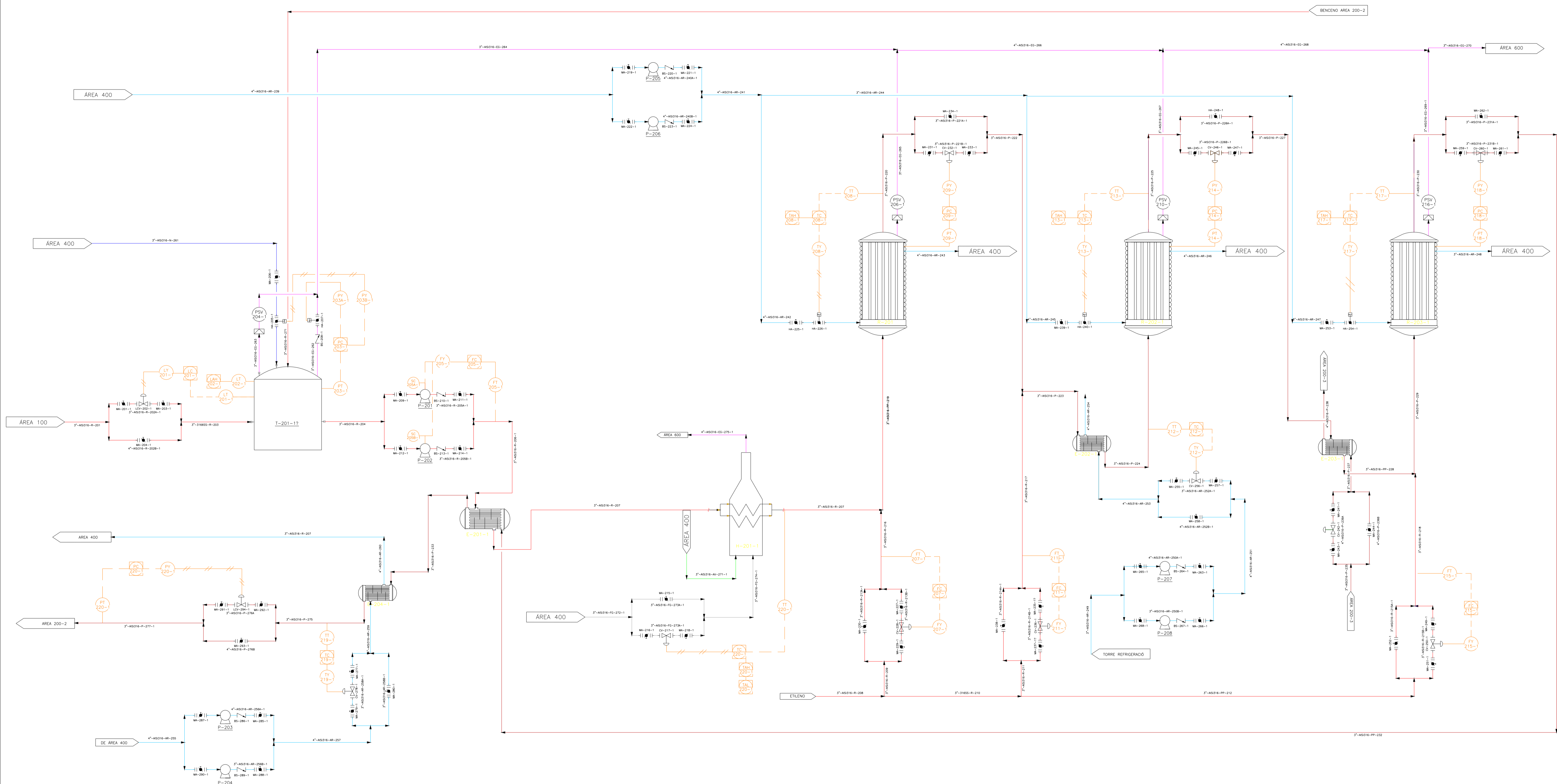

Plano n°:	03	P&ID Zona de alquiler (200-1)
Dibujado: 05/04/2023	Revisión: 21/04/2023	Fecha: 6/06/2023
Aprobado: 25/05/2023		Localización: Polígono gases nobles, Tarragona



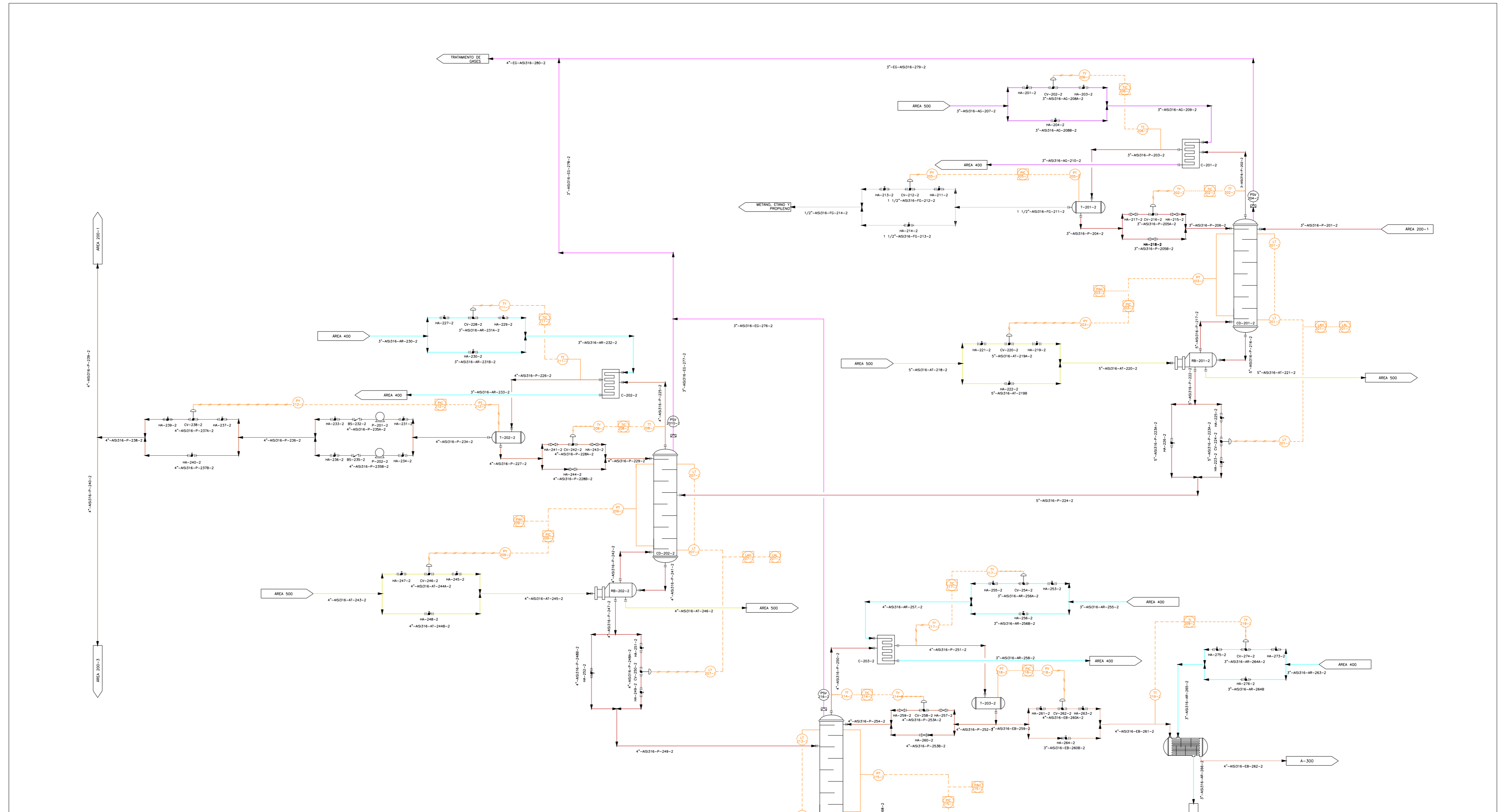

Plano nº: 04	A-200-2 Purificación del producto y recirculación
Dibujado: 04/05/2023 Revisión: 12/05/2023 Aprobado: 20/05/2023	Fecha: 25/05/2023 Localización: Polígono industrial Gases nobles, Tarragona



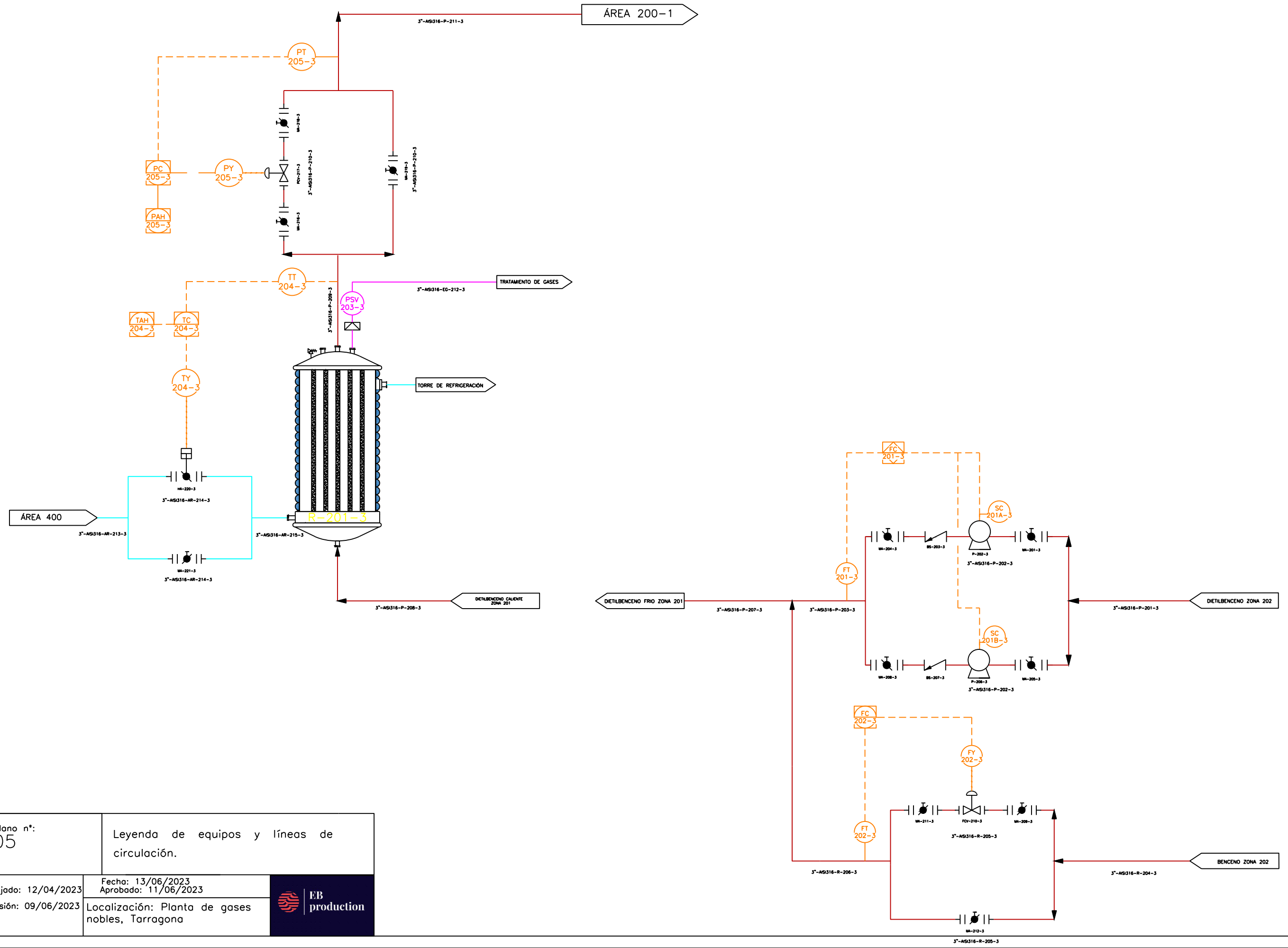



Plano n°: 05	Leyenda de equipos y líneas de circulación.	
Dibujado: 12/04/2023	Fecha: 13/06/2023	
Revisión: 09/06/2023	Localización: Planta de gases nobles, Tarragona	

Fecha: 13/06/2023
Aprobado: 11/06/2023

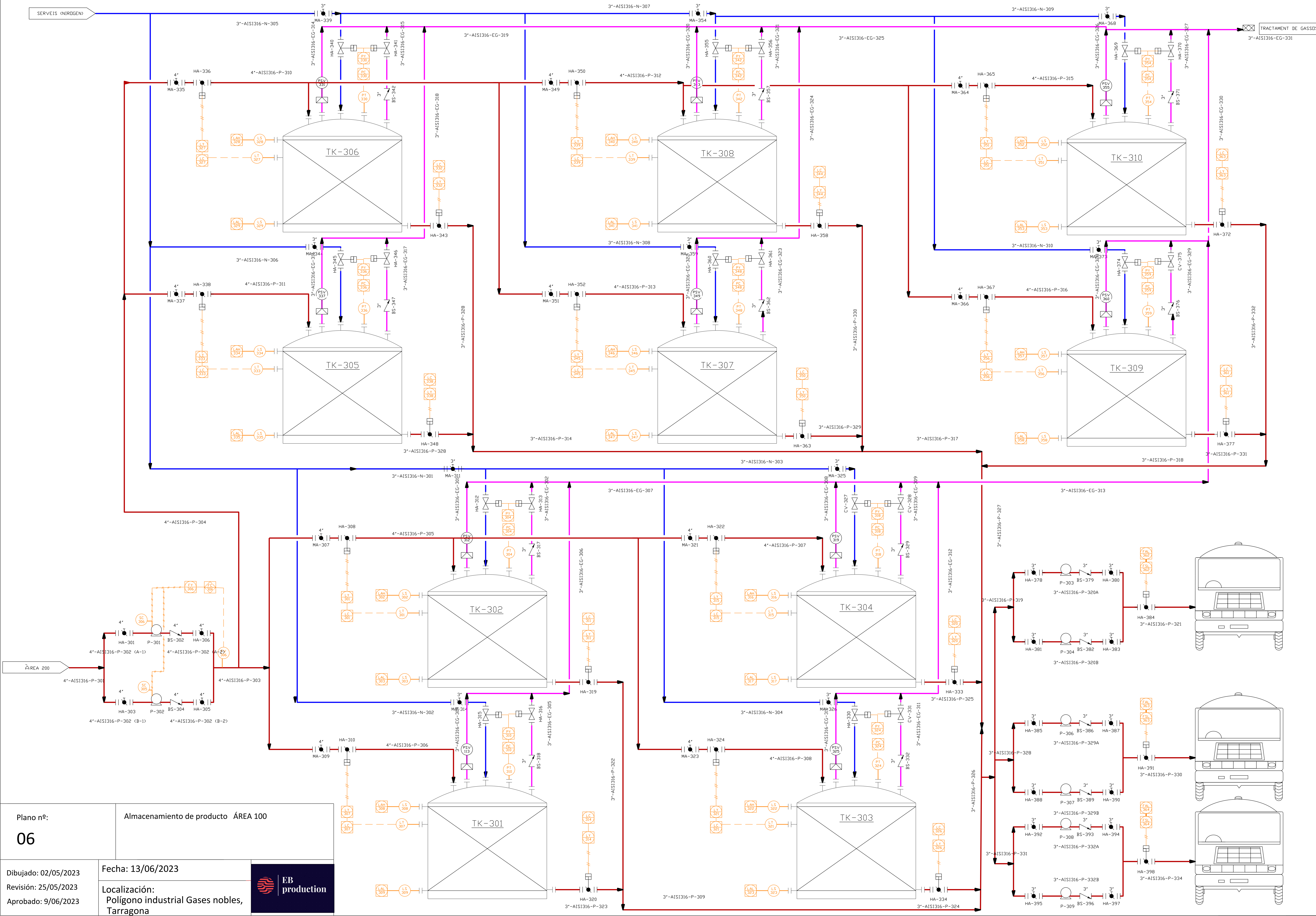



Plano nº: 06	Almacenamiento de producto ÁREA 100
Dibujado: 02/05/2023 Revisión: 25/05/2023 Aprobado: 9/06/2023	Fecha: 13/06/2023 Localización: Polígono industrial Gases nobles, Tarragona
	

C/ DE L'HELLI

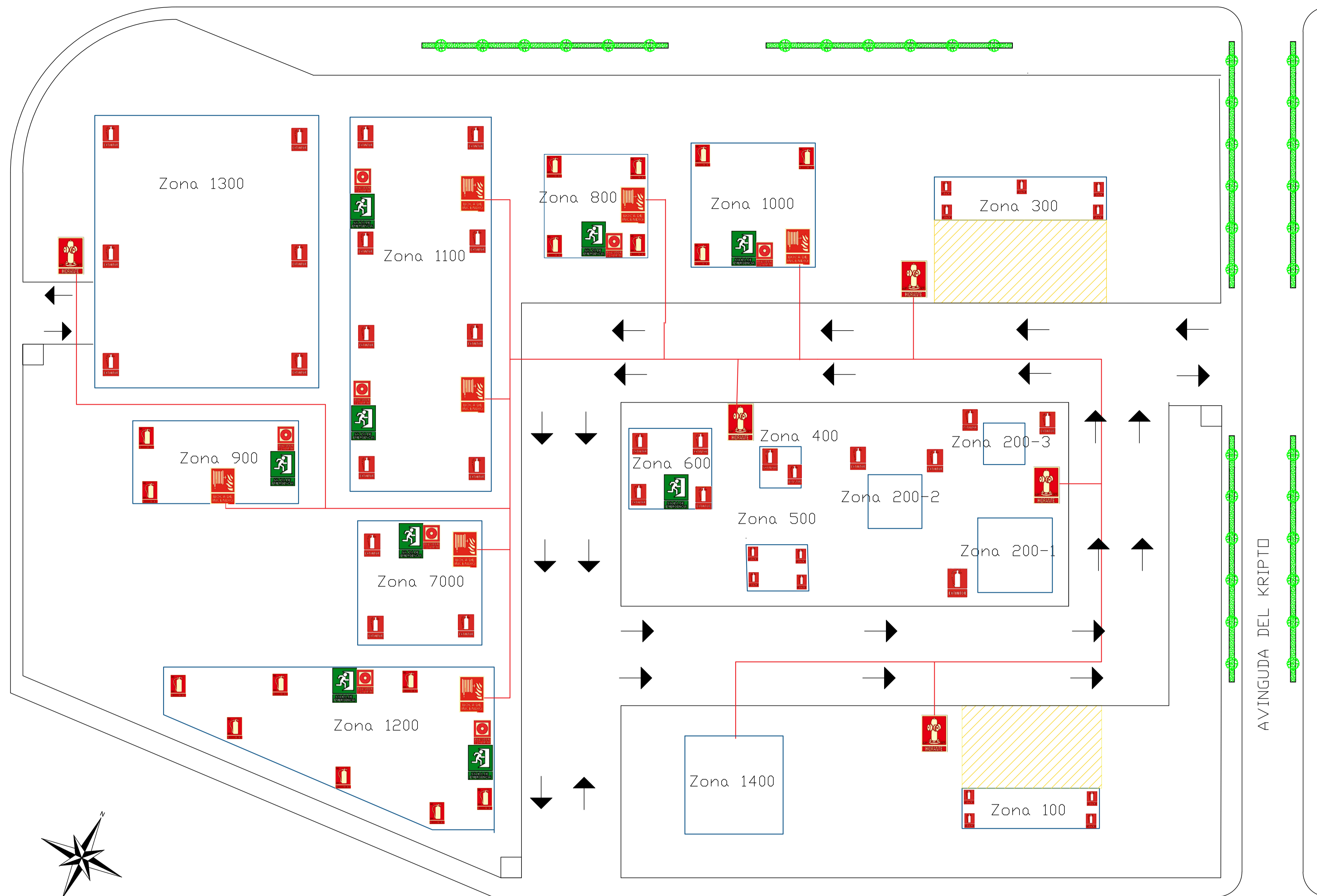

	Hidrante
	B.I.E
	Pulsador de alarma
	Extintor de espuma
	Extintor de polvo
	Salida de emergencia
	Línea de agua

AVINGUDA DEL KRIPTO

C/ DE L'ARGO

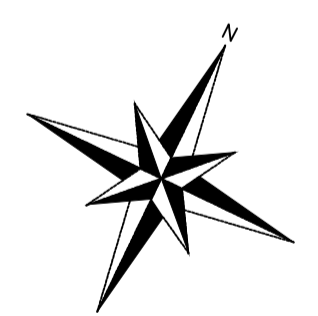

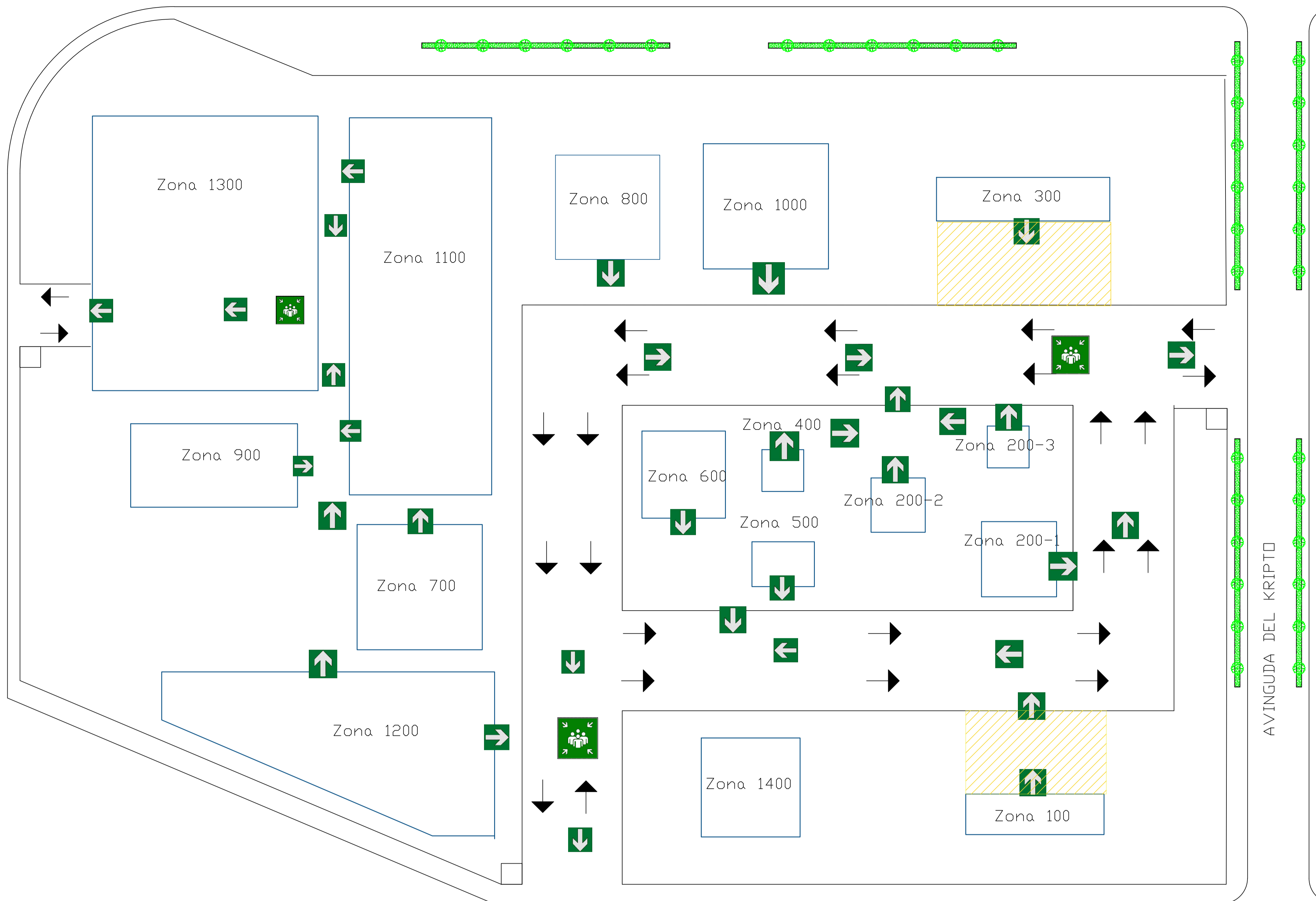

Plano:	7	Plano contra incendios
Dibujado: 9/5/2023	Fecha: 09/05/2023	
Revisión: 9/5/2023	Localización: Tarragona,	
Aprobado: 9/5/2023	Poligono industrial gases nobles	

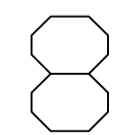

 Punto de reunion

 Ruta de emergencia

Plano:		Plano rutas de emergencia
Dibujado: 9/5/2023	Fecha: 09/05/2023	
Revisión: 9/5/2023	Localización: Tarragona,	
Aprobado: 9/5/2023	Poligono industrial gases nobles	